

Name: _____

Job Date: _____

Company: _____

Job Reference: _____

Cellular: _____

Roofing System: TPO PVC NDL Job: Yes No

Email: _____

If NDL, Rep Name: _____

Contractor: _____

Color: White Tan Gray Slate Gray Dark Bronze

Note: For multiple sizes and/or colors use additional quote forms. Want to fill out faster? Go online FlashCoMfg.com/Distributor-FlashForm

FLASHWRAP® - SPLIT BOOTS

Cylindrical Split Boot

Qty: _____

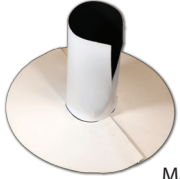

Size

1" 2" 3"

4" 5" 6"

Hose Clamp: Yes No

Made to actual size

Square/Rectangle Split Boot

Qty: _____

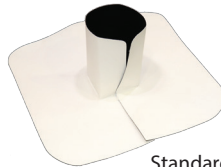

Size

2"x2"

4"x4"

Standard corner radius is 1/8"

Conical Split Boot

Qty: _____



Size

Bantam .5-1 (1/2"-1")

Welter 1-3 (1"-3")

Middle 3-5 (3"-5")

Cruiser 5-7 (5"-7")

Super 7-9 (7"-9")

Hose Clamp: Yes No

FLASHJACK™ - CLOSED BOOTS

Conical Boot

Qty: _____



Size

Bantam .5-1 (1/2"-1")

Welter 1-3 (1"-3")

Middle 3-5 (3"-5")

Cruiser 5-7 (5"-7")

Super 7-9 (7"-9")

Hose Clamp: Yes No

Molded Pipe Seal

Qty: _____



Size

6 in 1 Pre-Molded Universal (hose clamp included)

Available in white only

For Custom Sizes:

Use Custom Accessories FlashForm, or use Online FlashForm (FlashCoMfg.com/Distributor-FlashForm)

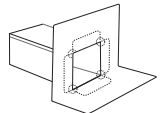
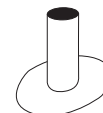

FLASHDRAIN™ - DRAINS

Retrofit Drain

Qty: _____



Size

2" 3" 4"

5" 6"

Fluted: Yes No

Target Patch: Yes No

Scupper (Reinforced)

Qty: _____



Size

4"W x 4"H x 12"D x 6"F

6"W x 4"H x 12"D x 6"F

Throughwall Overflow

Type: Center Corner

Drain Boot

Qty: _____



Size

2" 3"

Membrane only

Drop Outlet

Qty: _____



Size

2" 3"

Designed for external drainage

FLASHVENT™ - VENT FLASHINGS

Easy Flapper™

Qty: _____



Size

4" 6" 8"

Add Boot: Yes No

Sub Base & Boot/Assembly

Qty: _____



Size

4" 4" Oval 6"

8" 10" 12"

Boot Assembly

Breather Vent

Qty: _____



Size

4" Round

8" Square

One Way

Two Way

Gravity Vent

Qty: _____

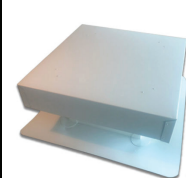

Size

12"x12"

18"x18"

24"x24"

Louver Vent

Qty: _____



Size

14" x 18"

12" x 12"

14" x 12"

T-Top & Square Top Vents

Qty: _____



Size

4" T-Top

6" T-Top

8" T-Top

8" Square Top

4"x12" T-Top Box

Eyebrow Vent

Qty: _____



Size 18" 24"

For 45° - 90° slopes

Wall Vent

Qty: _____

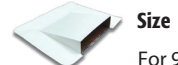

Size 12" 16" 24"

For 90° applications

FlashCap® Vent Boot

Qty: _____



Size

1 1/2" 2"

3" 4"

FLASHACCESSORY™ - ACCESSORIES

Coated Metal

Qty: _____

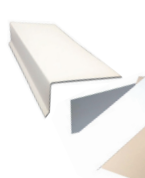

Size

2"x4"x10'

3"x3"x10'

4' x 10' Full Sheet

Sealant Pocket

Qty: _____

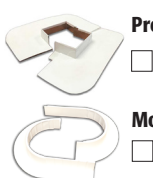

Pre-Fab Size

4"x4" 6"x6" 8"x8"

Molded Size

6" x 6"-12"

Corners

Qty: _____

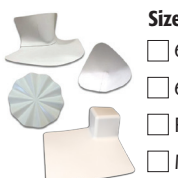

Size

6" Inside Corner

6" Outside Corner

Fluted Outside

Molded Inside/Outside

T-Joint Covers

Qty: _____ 100/bag



Size

4 1/2" Pre-Fab

4 1/2" Molded

Name: _____

Job Date: _____

Company: _____

Job Reference: _____

Cellular: _____

Roofing System: TPO PVC NDL Job: Yes No

Email: _____

If NDL, Rep Name: _____

Contractor: _____

Color: White Tan Gray Slate Gray Dark Bronze

Note: For multiple sizes and/or colors use additional quote forms. Want to fill out faster? Go online FlashCoMfg.com/Distributor-FlashForm

FLASHWRAP® - SPLIT BOOTS

Cylindrical Split Boot Qty: _____

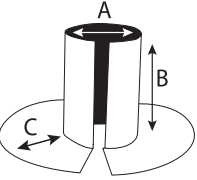

Custom Size
 A: Diam. _____ in.
 B: Height _____ in. (8" std.)
 C: Flange _____ in. (6" std.)
 Hose Clamp: Yes No

Square/Rect. Split Boot Qty: _____

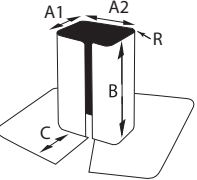

Custom Size
 A1: Tube: _____ in.
 A2: Tube: _____ in.
 B: Height _____ in. (8" std.)
 C: Flange _____ in. (6" std.)
 R: Radius _____ in. (1/8" std.)

Conical Split Boot Qty: _____

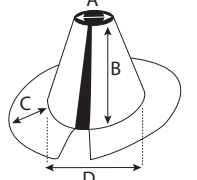

Custom Size
 A: Top Dia. _____ in.
 D: Btm Dia. _____ in.
 B: Height _____ in. (8" std.)
 C: Flange _____ in. (6" std.)
 Hose Clamp: Yes No

FLASHJACK™ - CLOSED BOOTS

Cylindrical Boot Qty: _____

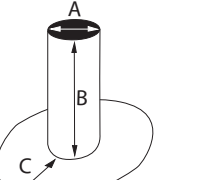

Custom Size
 A: Diam. _____ in.
 B: Height _____ in. (8" std.)
 C: Flange _____ in. (6" std.)
 Hose Clamp: Yes No

Built to size

Square/Rect. Boot Qty: _____

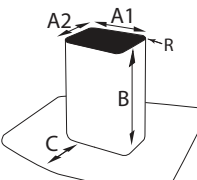

Custom Size
 A1: Tube: _____ in.
 A2: Tube: _____ in.
 B: Height _____ in. (8" std.)
 C: Flange _____ in. (6" std.)
 R: Radius _____ in. (1/8" std.)

Built to size

Conical Boot Qty: _____

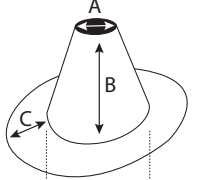

Custom Size
 A: Top Diam. _____ in.
 D: Btm Diam. _____ in.
 B: Height _____ in. (8" std.)
 C: Flange _____ in. (6" std.)
 Hose Clamp: Yes No

FLASHDRAIN™ - DRAINS

Scupper Qty: _____

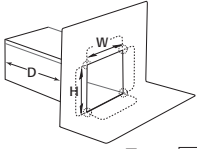

Custom Size
 W: Width _____ in.
 H: Height _____ in.
 D: Depth _____ in.
 Throughwall Overflow
 Type: Center R. Corner L. Corner

FLASHACCESSORY™ - ACCESSORIES

Sealant Pocket Qty: _____

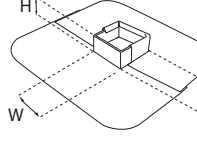

Custom Size
 W: Width _____ in.
 L: Length _____ in.
 H: Height _____ in. (2" std.)
 Split side is along L

Curb Wrap Qty: _____

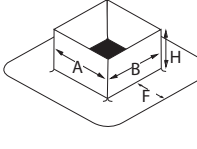

Configuration
 2 pcs 4 pcs
 Split Closed
 A: Dim. _____ in.
 B: Dim. _____ in.
 H: Height _____ in. (8" & 12" std.)
 F: Flange _____ in. (6" std.)

FLASHEDGE™ - COATED METAL

Drip Edge Qty: _____

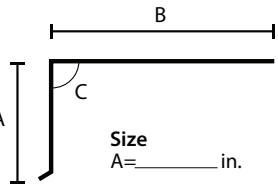

Options
 No Hem
 Hem Open
 Hem Closed
 Hem Return _____ in.

Size
 A = _____ in.
 B = _____ in.
 C = _____ deg.

Gravel Stop Drip Edge Qty: _____

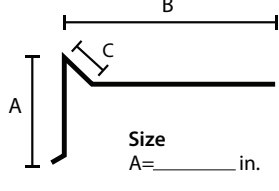

Options
 No Hem
 Hem Open
 Hem Closed
 Hem Return _____ in.

Size
 A = _____ in.
 B = _____ in.
 C = _____ in.

Cleat Qty: _____

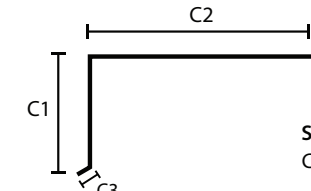

Size
 C1 = _____ in.
 C2 = _____ in.
 C3 = _____ in.

Cleat fits in Open Hem

Cap Metal Qty: _____



Options
 No Hem
 Hem Open
 Hem Closed
 Hem Return _____ in.

Size
 A = _____ in. B = _____ in. C = _____ in.

Z Bar Qty: _____

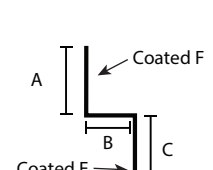

Size
 A = _____ in.
 B = _____ in.
 C = _____ in.
 Coated Side: E F

Roof To Wall/Starter Qty: _____

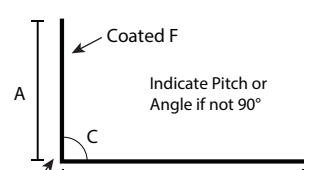

Size
 A = _____ in.
 B = _____ in.
 C = _____ deg.
 Coated Side: E F

Indicate Pitch or Angle if not 90°

Name: _____ Contractor: _____

Company: _____ Job Name: _____

Cellular: _____ Job Location: _____

Email: _____ Job Date: _____

Choose Options:

Type: TPO PVC

Color: White Tan Gray

Other: _____

Talk with your FlashCo Representative for special orders & material availability.

Notes:

- 6" standard reinforced membrane skirt with 3" of weldable flange beyond the tabs
- Standard 3" metal tabs for fastening to wall and deck
- Throat is coated 24g G90 steel

Throughwall Scupper (Center)

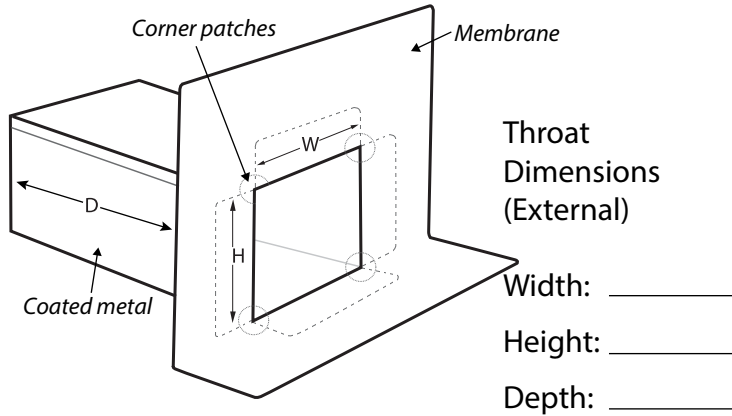

Weldable Memb. Flange (3" std.): _____ Qty. _____

Overflow Scupper

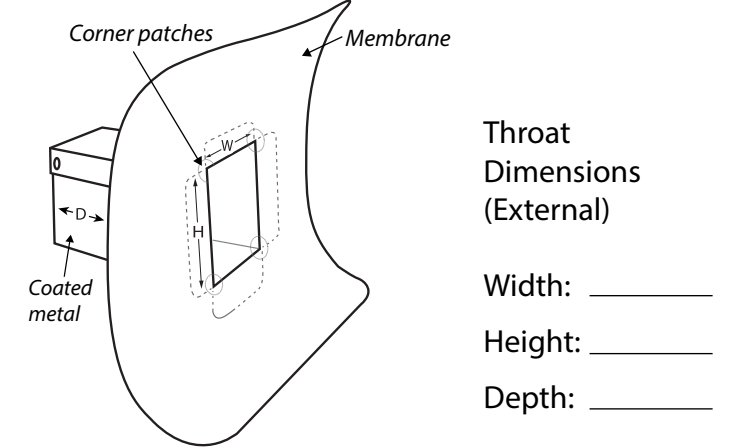

Weldable Memb. Flange (3" std.): _____ Qty. _____

Throughwall Scupper (Left Corner)

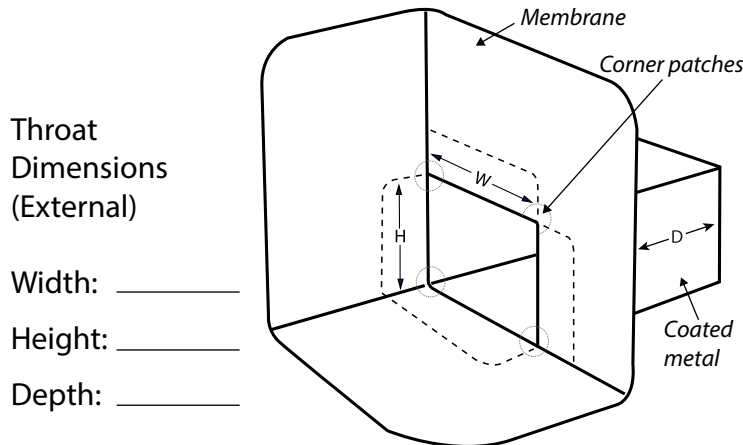

Qty. _____ Weldable Memb. Flange (3" std.): _____

Throughwall Scupper (Right Corner)

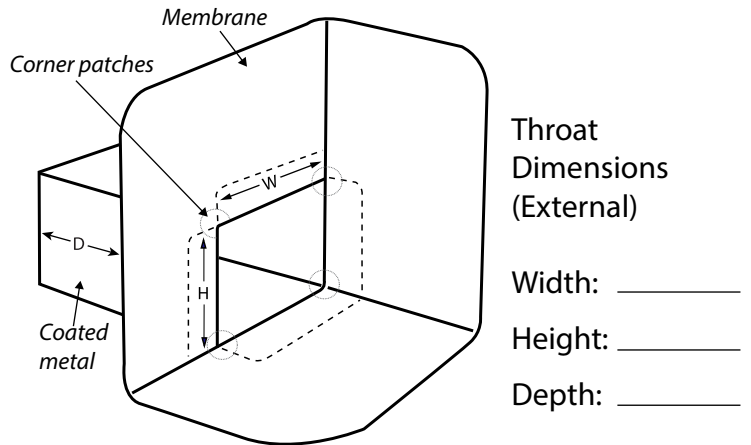

Weldable Memb. Flange (3" std.): _____ Qty. _____



COATED EDGE METAL QUOTE FORM

Email to: Sales@FlashCoMfg.com, or fax to: (707) 824-5858

Name: _____ Contractor: _____

Company: _____ Job Name: _____

Cellular: _____ Job City & State: _____

Email: _____ Job Date: _____

Choose Options:

Type: TPO PVC

Color: White Tan Gray

Dark Bronze Slate Gray

Other: _____

Talk with your FlashCo Representative for special orders & material availability.

Notes:

- All lengths of metal are 10' unless otherwise stated.
- Kick and hem are both included in pullout total measurement
- Standard edge is 3/8" and 30° away from the vertical.
- Sold in bundles of 10.

Drip Edge

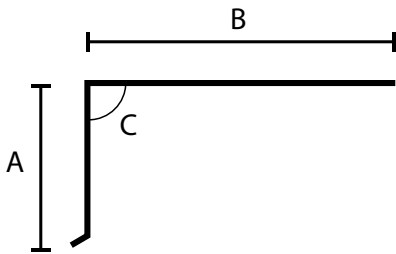

Size
 A= _____ in.
 B= _____ in.
 C= _____ deg.

Options
 No Hem
 Hem Open
 Hem Closed

Quantity _____

Hem Return _____ in.

Gravel Stop Drip Edge

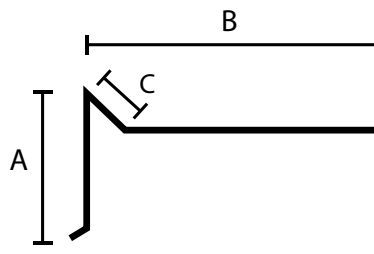

Size
 A= _____ in.
 B= _____ in.
 C= _____ in.

Options
 No Hem
 Hem Open
 Hem Closed

Quantity _____

Hem Return _____ in.

Cleat

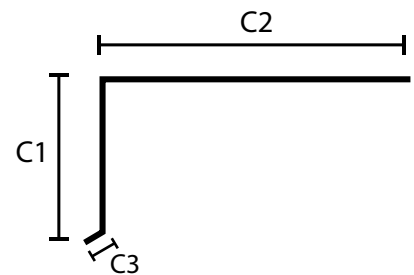

Size
 C1= _____ in.
 C2= _____ in.
 C3= _____ in.

Quantity _____

Cleat fits in Open Hem

Cap Metal

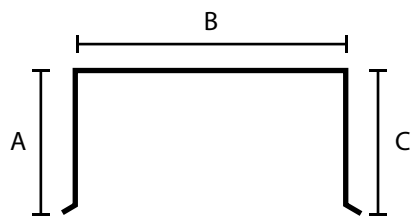

Size
 A= _____ in.
 B= _____ in.
 C= _____ in.

Options
 No Hem
 Hem Open
 Hem Closed

Quantity _____

Hem Return _____ in.

Z Bar

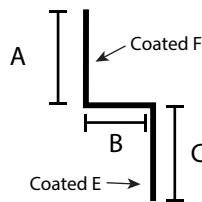

Size
 A= _____ in.
 B= _____ in.
 C= _____ in.

Quantity _____

Coated Side:
 E F

Roof To Wall/Starter

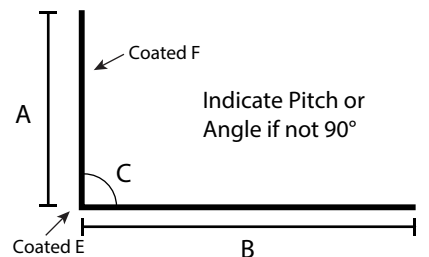

Size
 A= _____ in.
 B= _____ in.
 C= _____ deg.

Quantity _____

Coated Side:
 E F